

Technical sheet :

# **COMPETITIVE CARRIAGE INTERFACE**

---

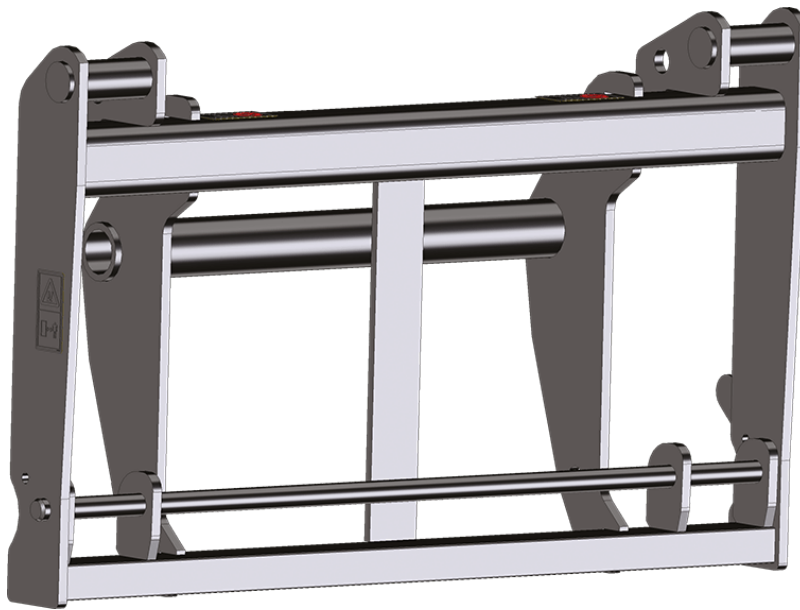

## **Benefits**





- Allows the use of attachments with competitive brackets on standard MANITOU machines (MANITOU carriage).
- Note: specific safety rules apply, contact your MANITOU dealer.

## **Technical characteristics**

- Steel converter, designed to be positioned on a Manitou apron and be able to receive the attachments with a JCB-type hook.
- The maximum capacity is 4100 kg and the interface weighs 155 kg.
- Warning: This adds a 330 mm outreach, the center of gravity is then modified.

Capacities		IC-JCB
Capacity (lb)		9038.95
Weight and dimensions		
Overall length (in)	l1	1'
Overall height (in)	h17	2' 7"
Width (in)		4' 3"
Depth (in)	p5	1' 1"
Overall weight (lb)		341.72
Working Parameters		
Machine Equipement		✕
Other Data for Attachments		
Carriage type		JCB

Machines compatibility		IC-JCB
Reference number		52000231
ALT950		X
ALT950		X
MLA-T 533-145 V+ - ST5		X
MLT 630-115		X
MLT 630-115 V		X
MLT 630-115 V CP		X
MLT 635-130 PS+		X
MLT 635-140 V+		X
MLT 730-115 V		X
MLT 730-115 V CP		X
MLT 737-130 PS+		X
MLT 741-130 PS+		X
MLT 741-140 V+		X
MLT 841-145 PS+		X
MLT 1041-145 PS+L		X
MLTX 735 T LSU		X
MLTX 737-130 PS+		X
MLTX 741-140 V+		X
MLTX 841 - 145 PS+		X
MLTX 1041-145 PS+L		X
MLT 630-105 ST4 <b>OLD</b>		X
MLT 630-105 V CP ST4 <b>OLD</b>		X
MLT 630-105 V ST4 <b>OLD</b>		X
MLT 635-130 PS+ ST4 <b>OLD</b>		X
MLT 635-140 V+ ST4 <b>OLD</b>		X
MLT 730-115 V CP ST4 <b>OLD</b>		X
MLT 730-115 V ST4 <b>OLD</b>		X
MLT 737-130 PS+ ST4 <b>OLD</b>		X
MLT 840-145 PS+ <b>OLD</b>		X
MLTX 840-140 PS+ <b>OLD</b>		X

TABLE SYMBOL					
	No predisposition required		Hydraulic line		Return piping to hydraulic oil tank
	Electric predisposition		Platform predisposition		Tyre handler, cylinder handler predisposition

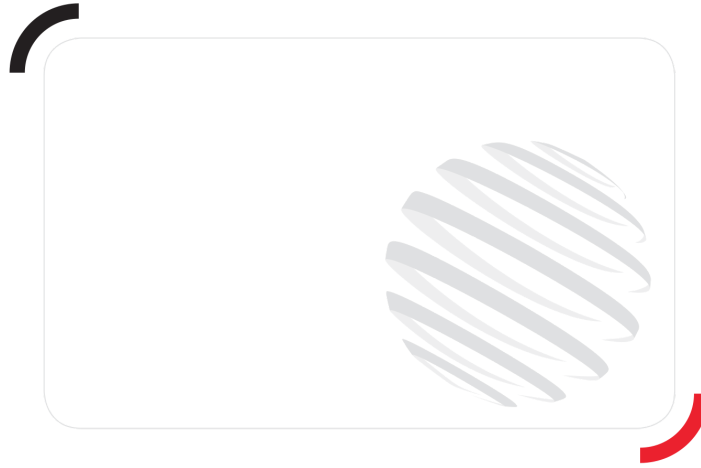

**Head Office**

B.P. 249 - 430 rue de l'Aubinière

44150 Ancenis Cedex - France

Tel: +33 (0)2 40 09 10 11 - Fax: +33 (0)2 40 09 10 97

[www.manitou.com](http://www.manitou.com)



This publication provides a description of the configuration versions and options for Manitou products, which may differ for equipment. The equipment presented in this brochure may be part of a series, as an option, or it may not be available, depending on the versions. Manitou reserves the right, at any time and without notice, to amend the specifications described and represented. The specifications provided do not bind the manufacturer. For more details, please contact your Manitou agent. This is not a contractually binding document. The presentation of the products is not contractually binding. List of specifications non-exhaustive. The logos as well as the visual identity of the company are owned by Manitou and cannot be used without authorisation. All rights reserved. The photos and diagrams contained in this brochure are only provided for consultation and information purposes.

MANITOU BF SA - Limited company with board of directors - Share capital: 39 547 824 euros - 857 802 508 RCS Nantes